

Rozumienie ze słuchu

1 Postłuchaj nagrania i ponumeruj obrazki.

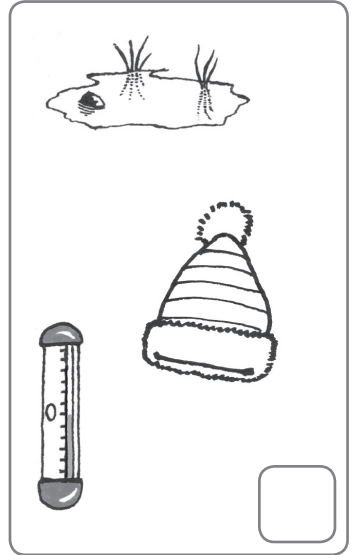
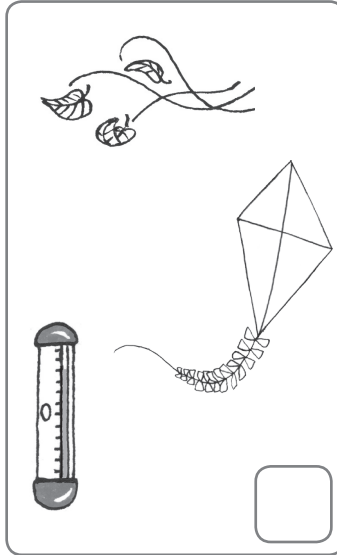
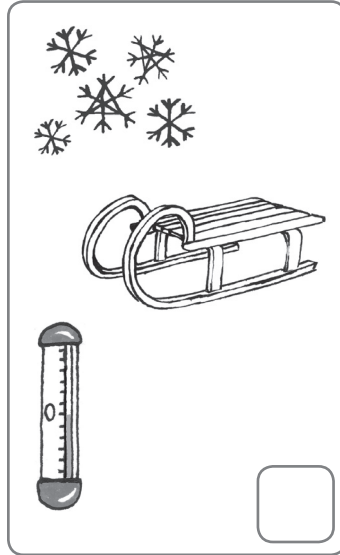
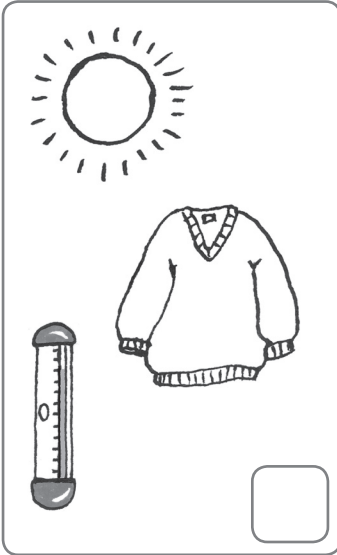

Score _____ / 4

2 Postłuchaj nagrania i otocz pętlą właściwe obrazki.

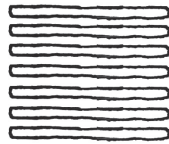

Score _____ / 4

Rozumienie tekstu pisanego

3 Zakreśl w każdym rzędzie jeden wyraz, który nie pasuje do pozostałych.

1 hot jeans warm cold

2 wet foggy hat cloudy

3 happy t-shirt shorts skirt

Score _____ / 3

Słownictwo

4 Popatrz na obrazki i w każdym rzędzie zapisz po śladzie jeden, właściwy wyraz.

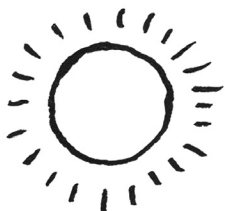

foggy / sunny / wet

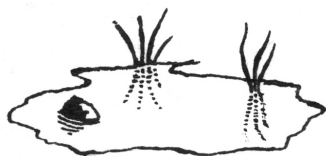

wet / hat / windy

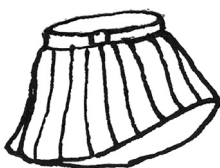

shorts / skirt / snowy

Komunikacja

5 Przeczytaj i pokoloruj pary.

What's the weather like?

I'm cold!

I'm hot!

Take off a hat!

Put on a sweater!

It's foggy and wet.

Score _____ / 3

*Rozumienie tekstu pisanego

6 Przeczytaj wyrażenia i pokoloruj obrazek.

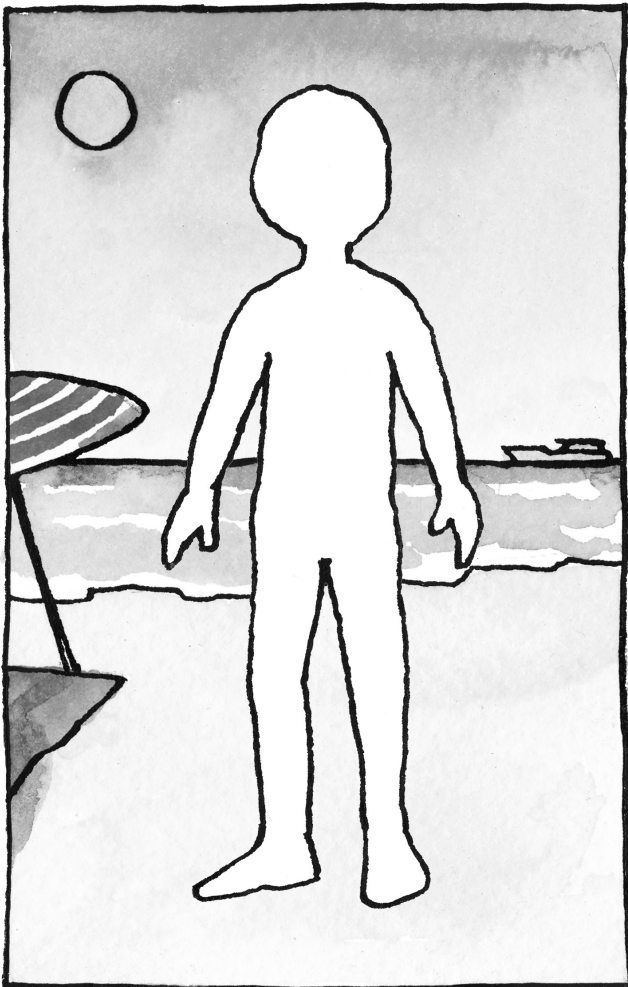

It's a sunny day.

It's hot.

Kate's got a green T-shirt
and a yellow skirt.